

This Space For Architect/Engineer Approval

Job Name \_\_\_\_\_ Date \_\_\_\_\_  
 Model Specified \_\_\_\_\_ Quantity \_\_\_\_\_  
 Customer/Wholesaler \_\_\_\_\_  
 Contractor \_\_\_\_\_  
 Architect/Engineer \_\_\_\_\_

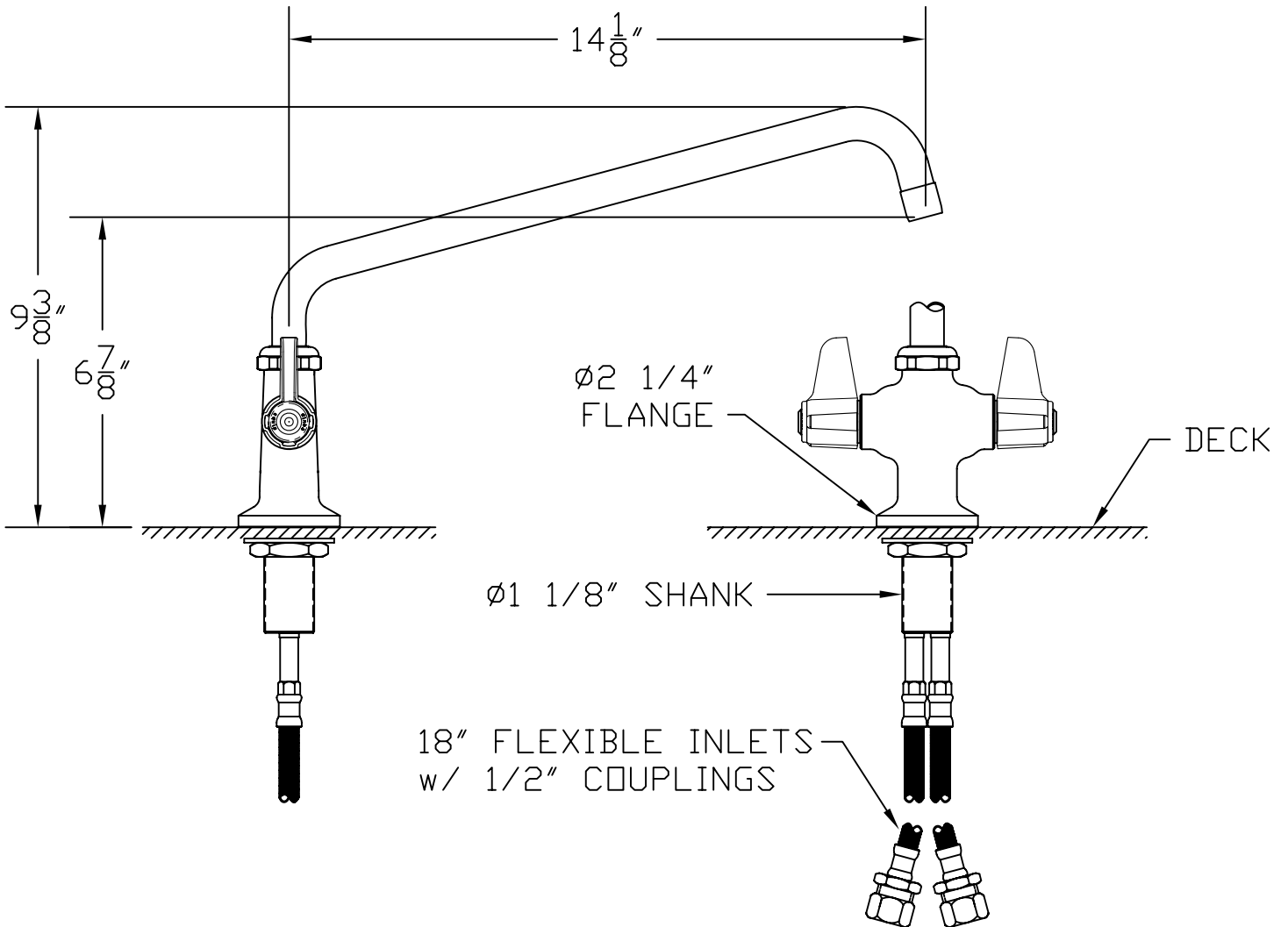

DIMENSIONS ARE APPROXIMATE

MODEL NUMBER 5F-2SLX14	DATE 3/21/06	SCALE 1:4	DRAWN DHL	CHECKED WJS	APPROVED JHB
---------------------------	-----------------	--------------	--------------	----------------	-----------------



DESCRIPTION

SINGLE HOLE DECK MOUNT  
 FAUCET WITH 14" SWING NOZZLE

equip Foodservice Accessories  
 P.O. BOX 1088, 2 SADDLEBACK COVE  
 TRAVELERS REST, SOUTH CAROLINA 29690  
 PHONE: 800.891.4808 FAX: 800.868.0084