

This Space For Architect/Engineer Approval

Job Name _____ Date _____

Model Specified _____ Quantity _____

Customer/Wholesaler _____

Contractor _____

Architect/Engineer _____

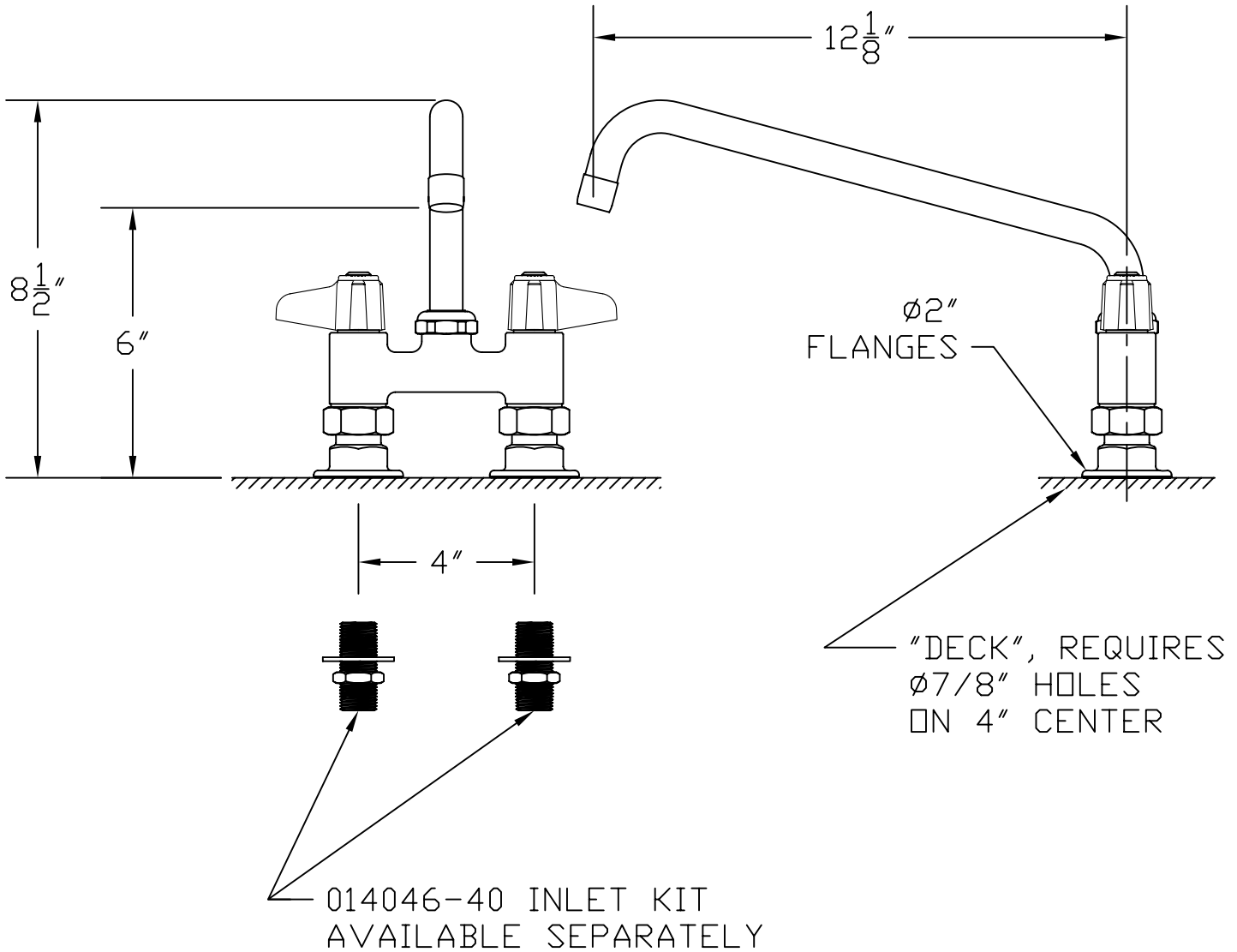

DIMENSIONS ARE APPROXIMATE

MODEL NUMBER 5F-4DLX12

DATE 3/21/06

SCALE 1:4

DRAWN DHL

CHECKED WJS

APPROVED JHB



DESCRIPTION

4" DECK MOUNT FAUCET WITH 12" SWING NOZZLE

equip Foodservice Accessories
P.O. BOX 1088, 2 SADDLEBACK COVE
TRAVELERS REST, SOUTH CAROLINA 29690
PHONE: 800.891.4808 FAX: 800.868.0084