



T&S BRASS AND BRONZE WORKS, INC.

2 SADDLEBACK COVE / P.O. BOX 1088 / TRAVELERS REST, SC 29690

(803) 834-4102 TELEX 57-0311 FAX (803) 834-3518

Model No.

B-0233-02

Item No.:

Job Name:

Architect/Engineer Approval:

Notes:



ADA COMPLIANT

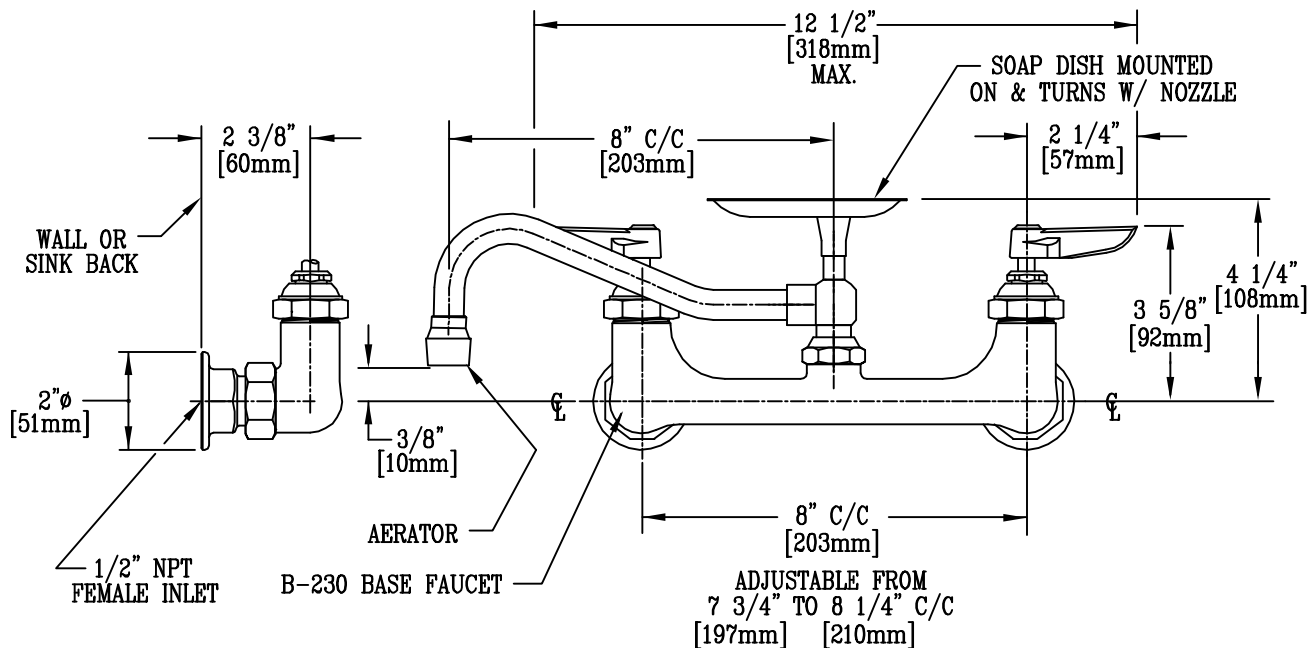

NOTE:

- 1) ALSO AVAILABLE WITH B-WH-4" OR B-WH-6" WRIST ACTION BLADE HANDLES.

Product Description:

SINK MIXING FAUCET WITH 8" SOAP DISH NOZZLE.

Drawn:

EST

Checked

Scale:

3" = 1'

Approved

Date:

7/24/03