



T&S BRASS AND BRONZE WORKS, INC.

2 SADDLEBACK COVE / P.O. BOX 1088 / TRAVELERS REST, SC 29690

PHONE 800-476-4103

FAX 864-834-3518



REG.#A2601
ISO #9002

Model No.

BL-4210-0

Item No.:

Job Name:

Architect/Engineer Approval:

Notes:

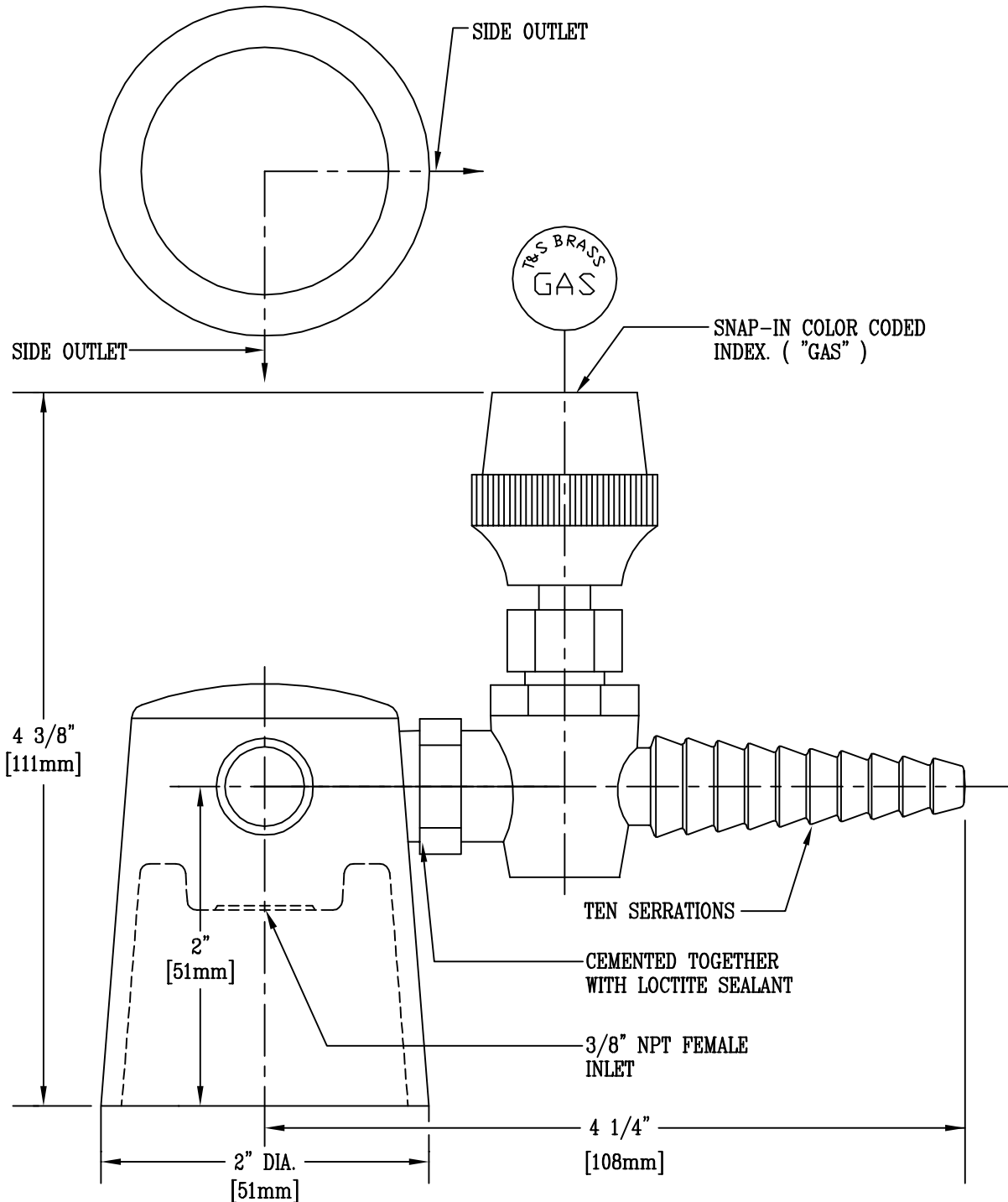

Product Description:

TAPERED LABORATORY TURRET WITH
(2) 90 DEGREE NEEDLE HOSE COCKS

Drawn:

JKD

Approved

CA

Checked

MVW

Scale:

1' = 1'

Date:

4/14/98